

# Input module audio board

2016-04-15

1. (34 or 26) 16 pin IC sockets.

Note direction.

“U1” and “U2” are 8 pin IC’s next to each other, so together they use a 16 pin socket.

The full module gets all 34 sockets, shown red and green.

The basic module gets only 26 sockets, shown in green.

To make sure it is seated, solder one pin then check. Reheat if necessary.

Then solder the other pins.

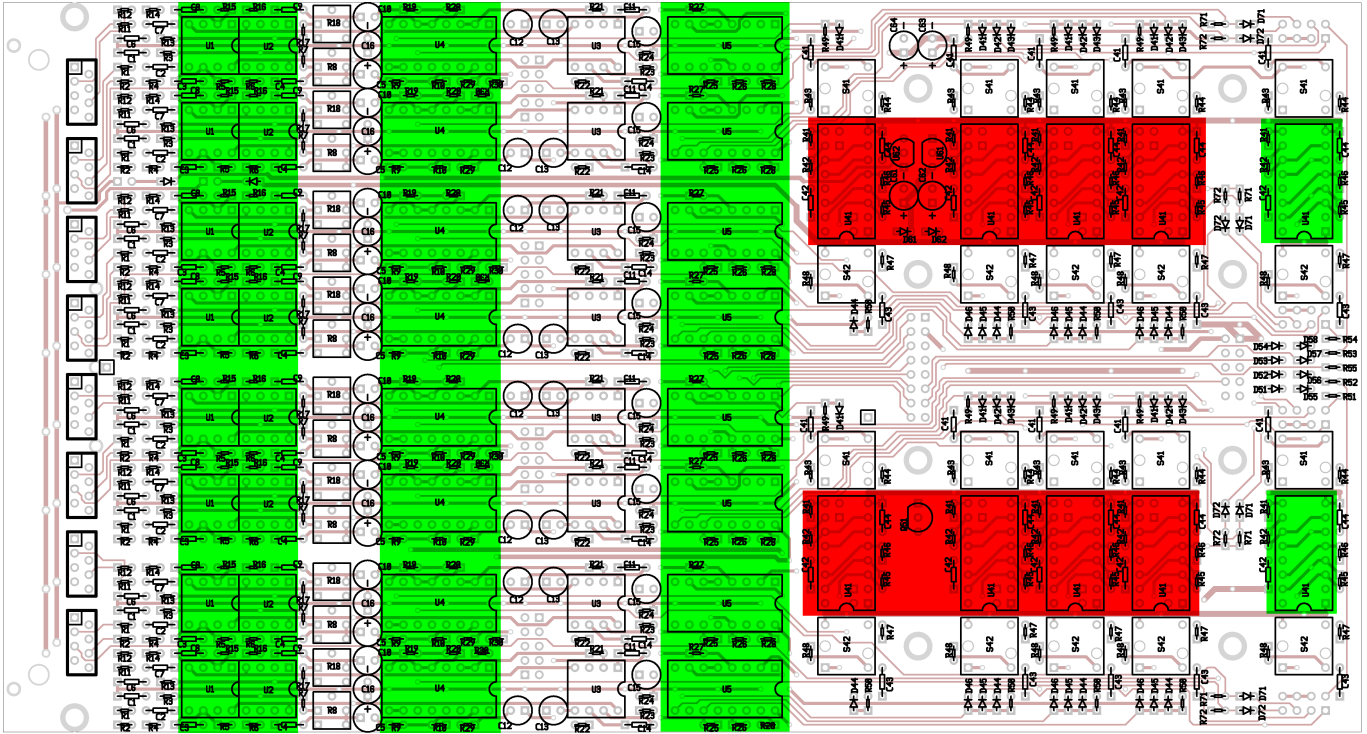

2. (8) 8 pin IC sockets

3. (16) 20k trim pots, marked “203”.

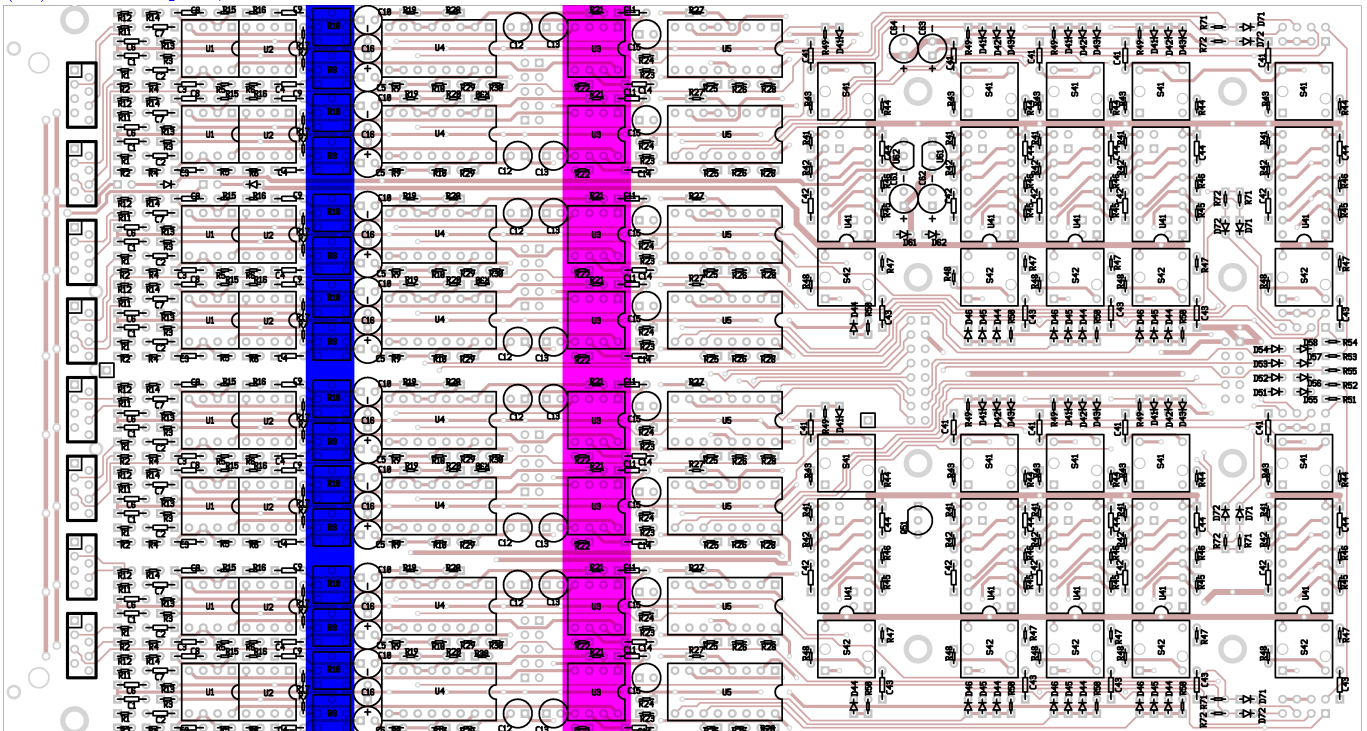



51. (48) 22 pf ceramic capacitors ("220" or "22J")

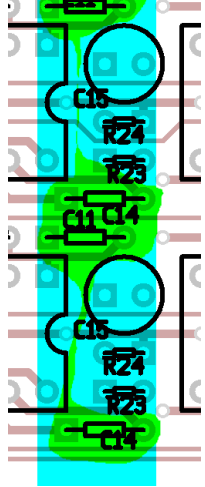
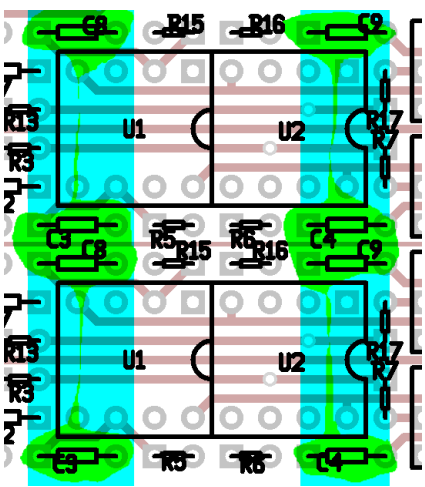
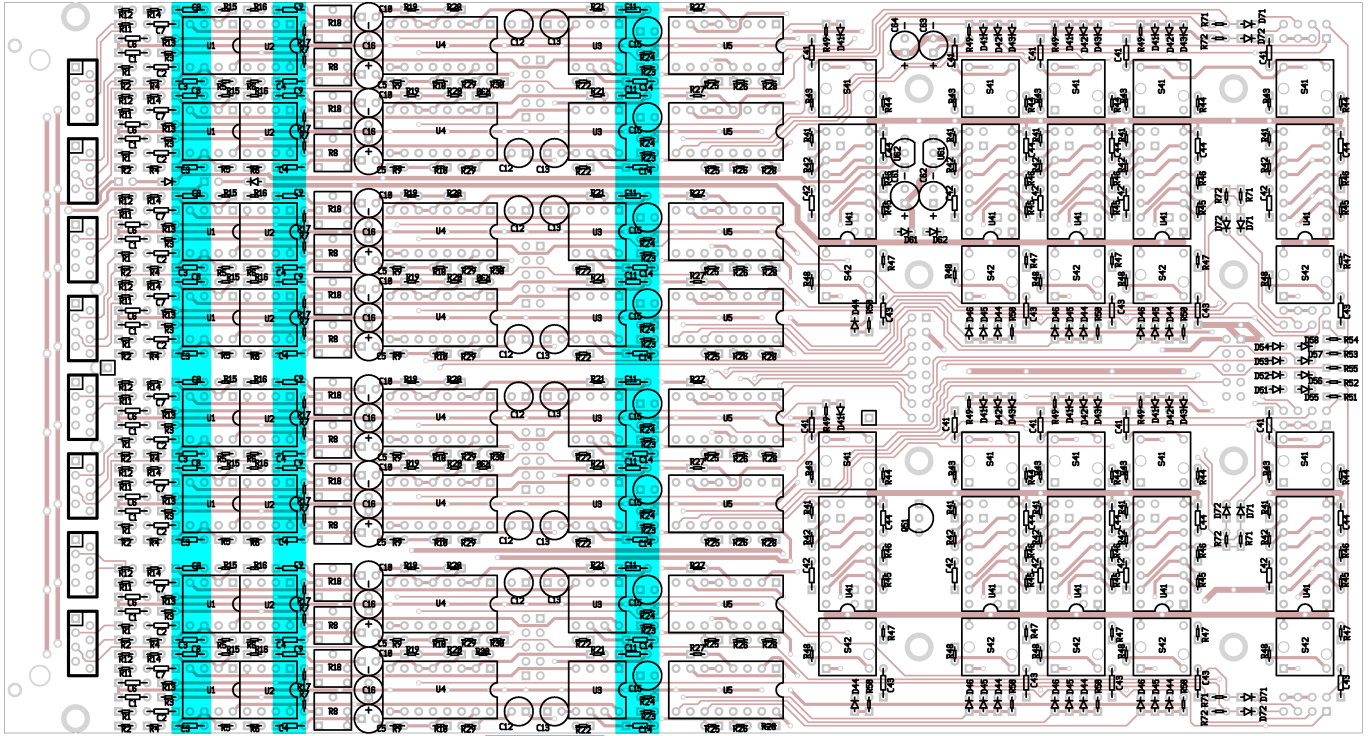

6. (40 or 8) .1 uf ceramic capacitors (“104”)

The full module gets all 40 .1 uf capacitors, shown both red and green.

The basic module gets only 8 of them, shown in green.

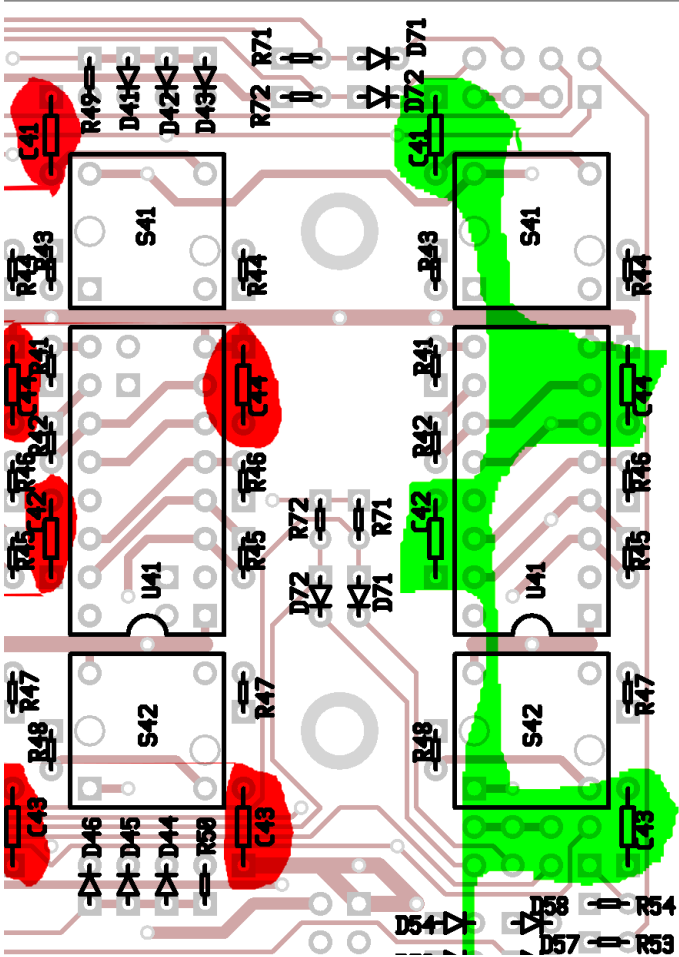
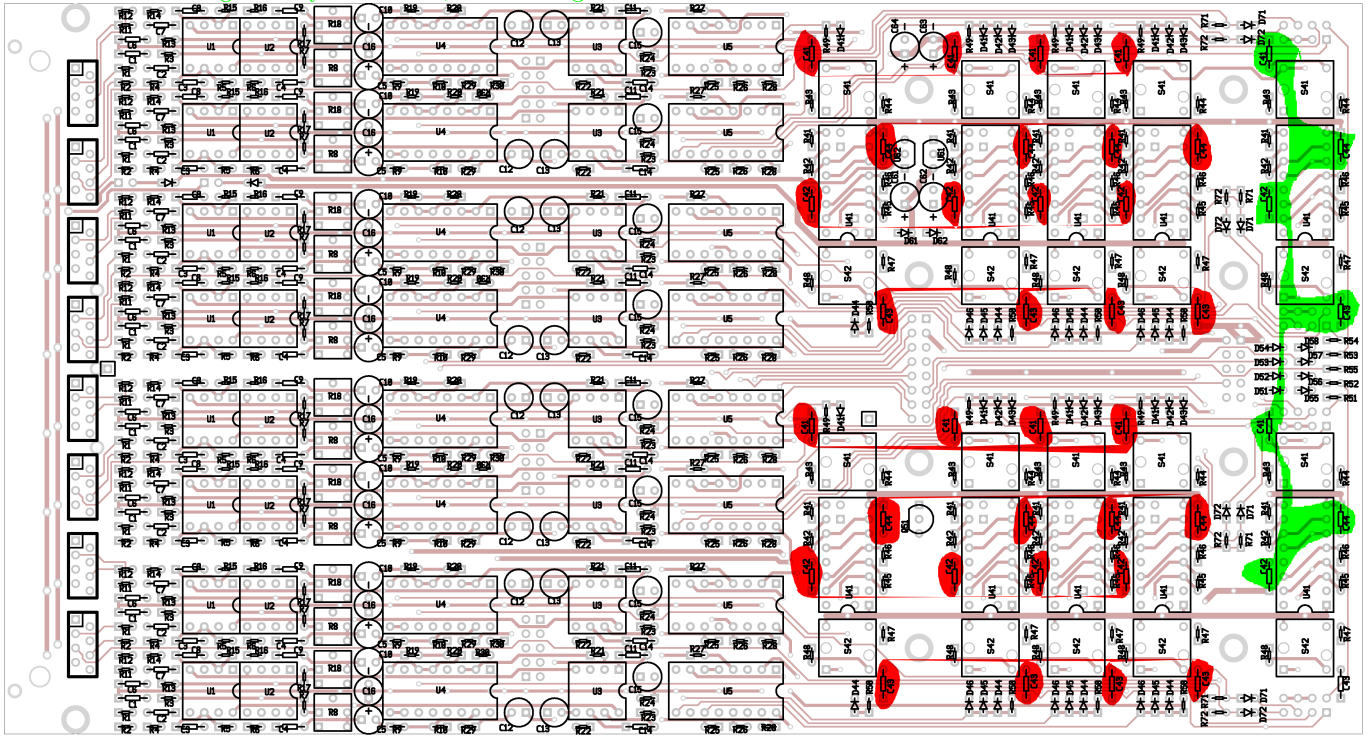

7. (56) 1N4148 (small) diodes

Note polarity! The stripe is the “cathode”, matches the bar on the diagram.

Bend leads so the stripe is up. Install so the body is at the fat end of the triangle.

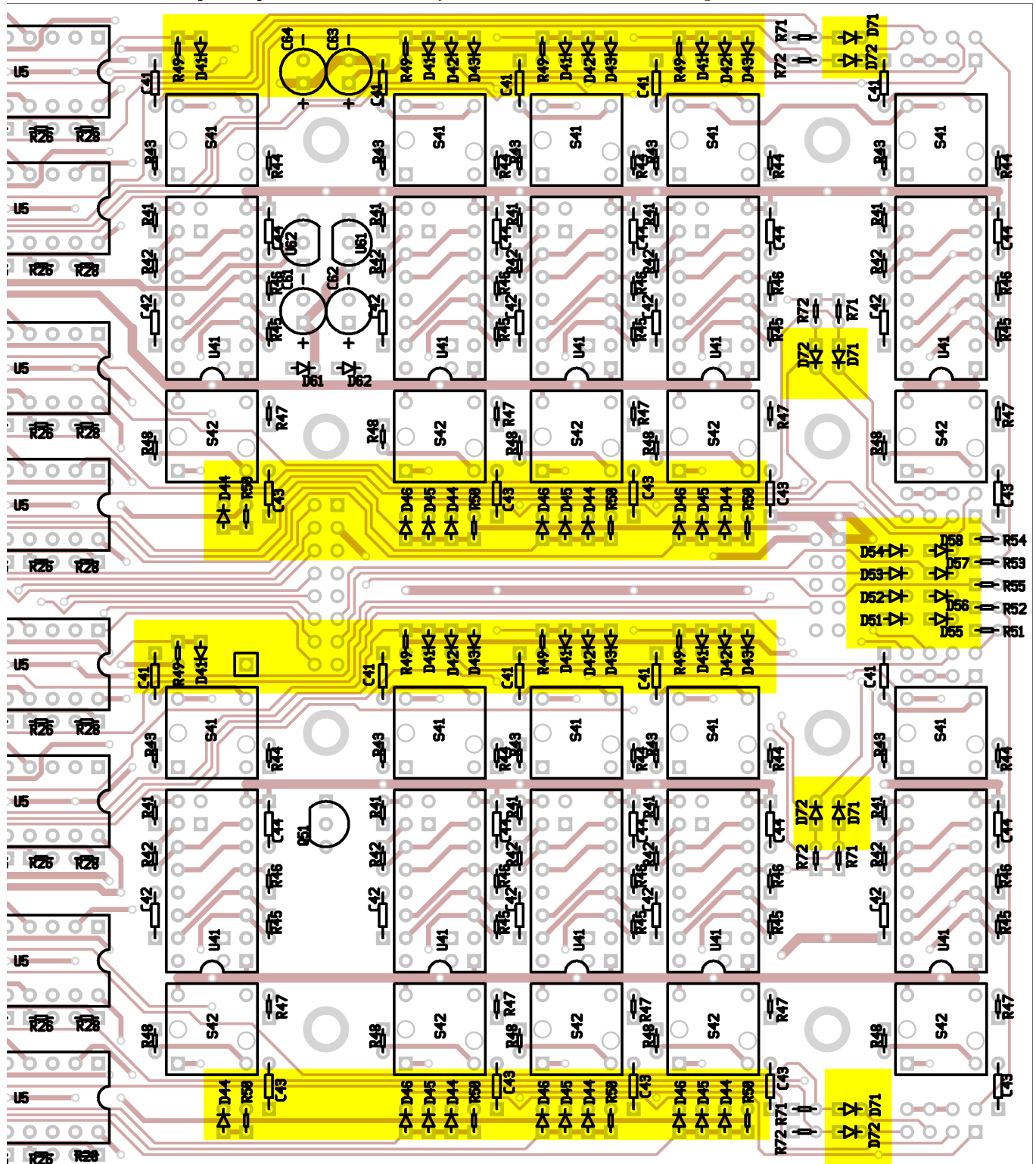

8. (56) 3320 ohm (3.32k) resistors (orange orange red brown brown) ("33211")

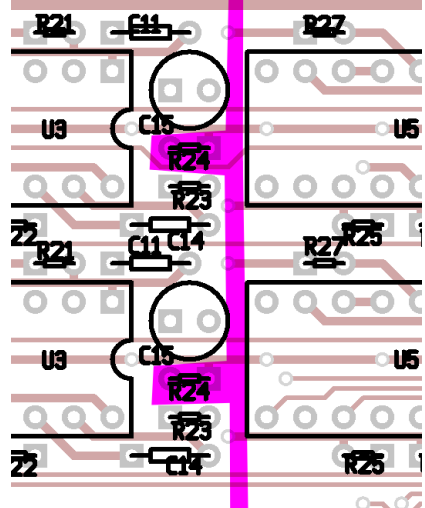
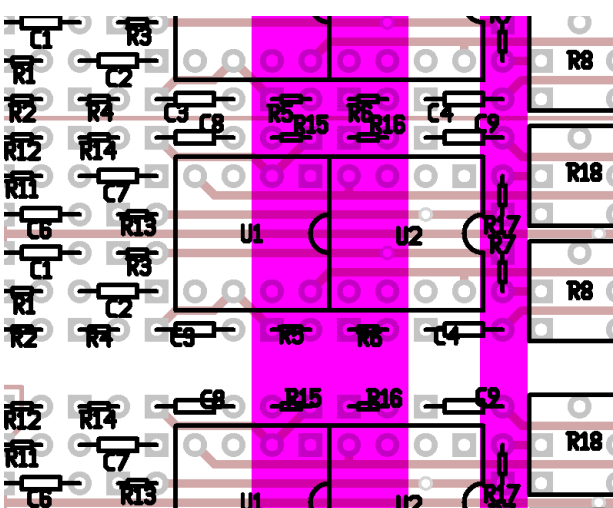
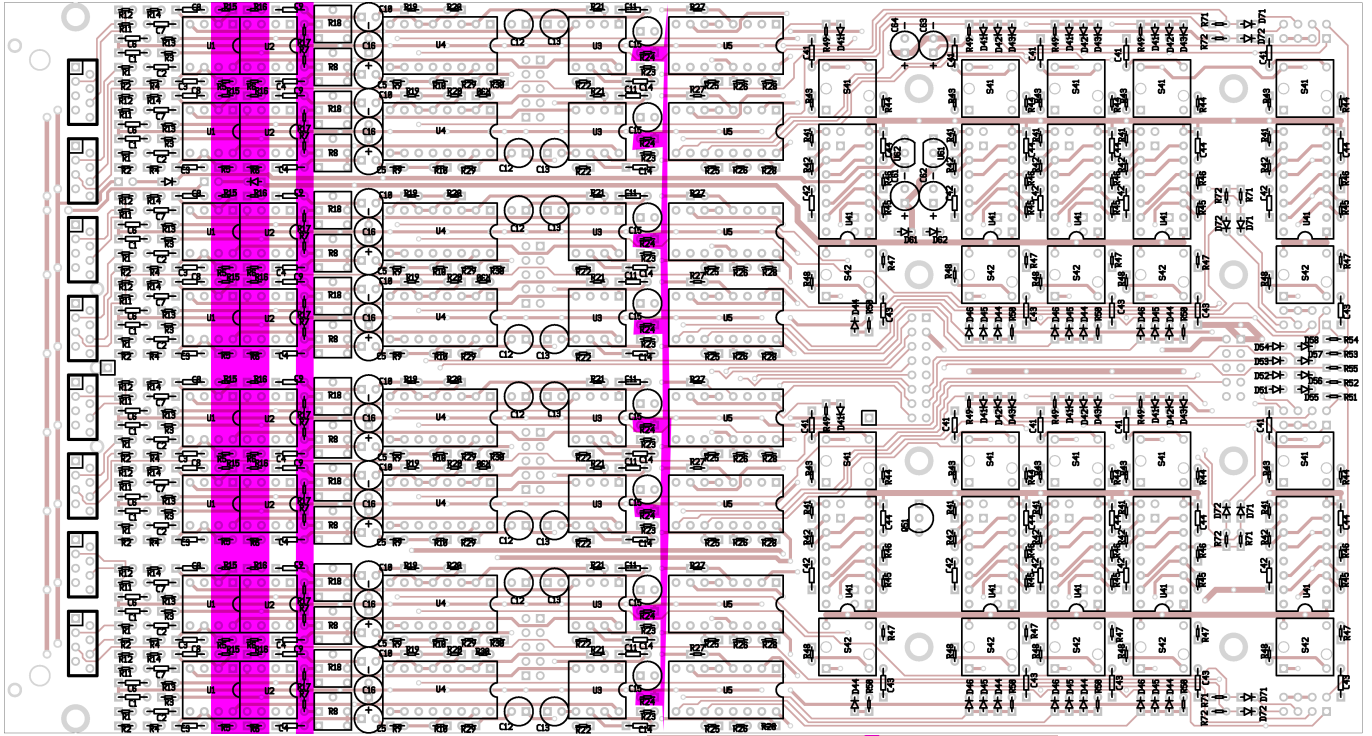

9. (116 or 100) 10k resistors (brown black black red brown) ("10021")  
 The full module gets all 116 10k resistors, shown in both red and green.  
 The basic module gets only 100 of them, shown in green.

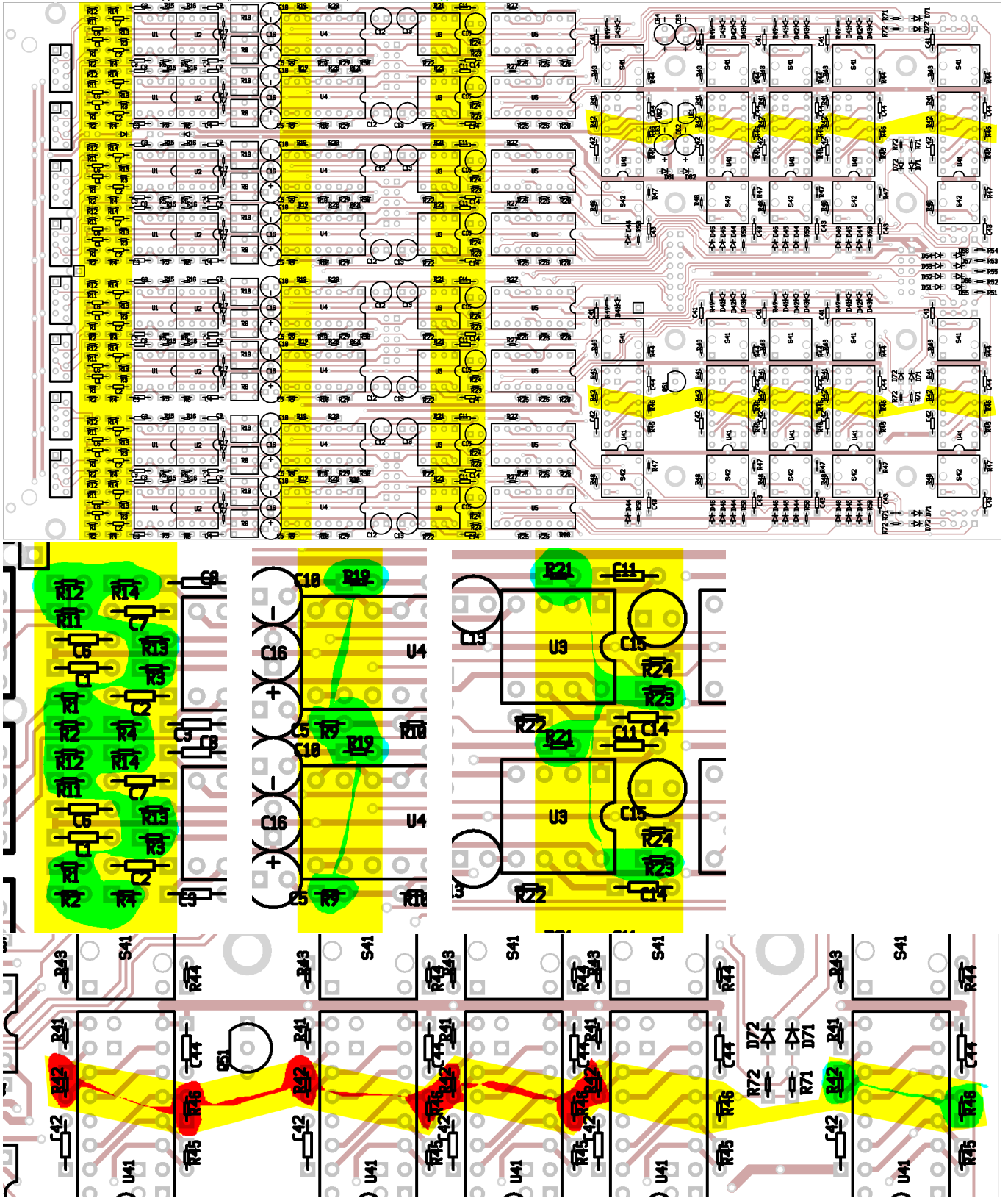

10. (32) 40.2k (yellow black red red brown) (“40221”)

11. (32) 20k (red black black red brown) (“20021”)

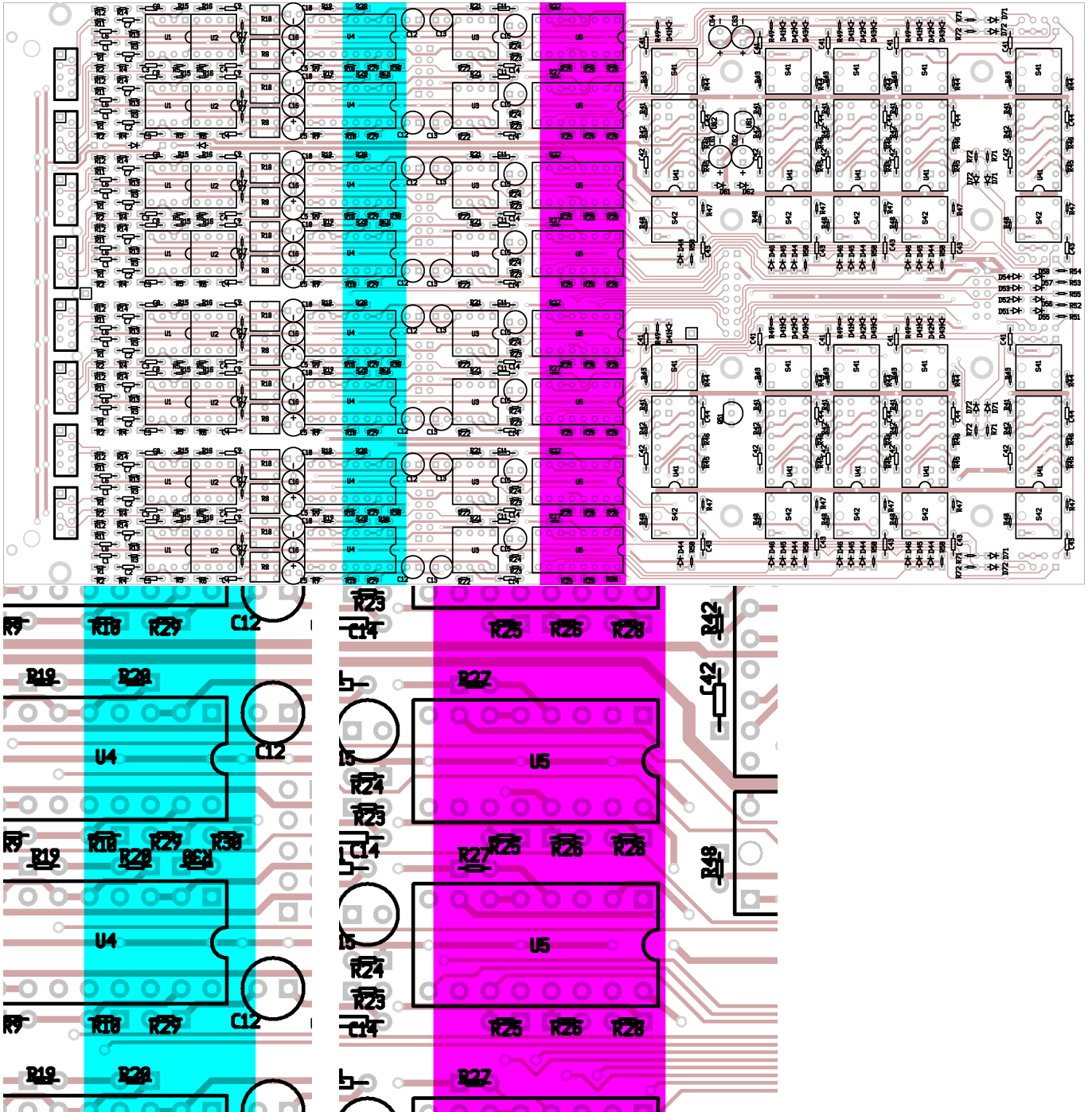



12. (57 or 41) 100k resistors (brown black black orange brown) (“10031”)  
 The full module gets all 57 100k resistors, shown both red and green.  
 The basic module gets only 41 of them, shown in green.

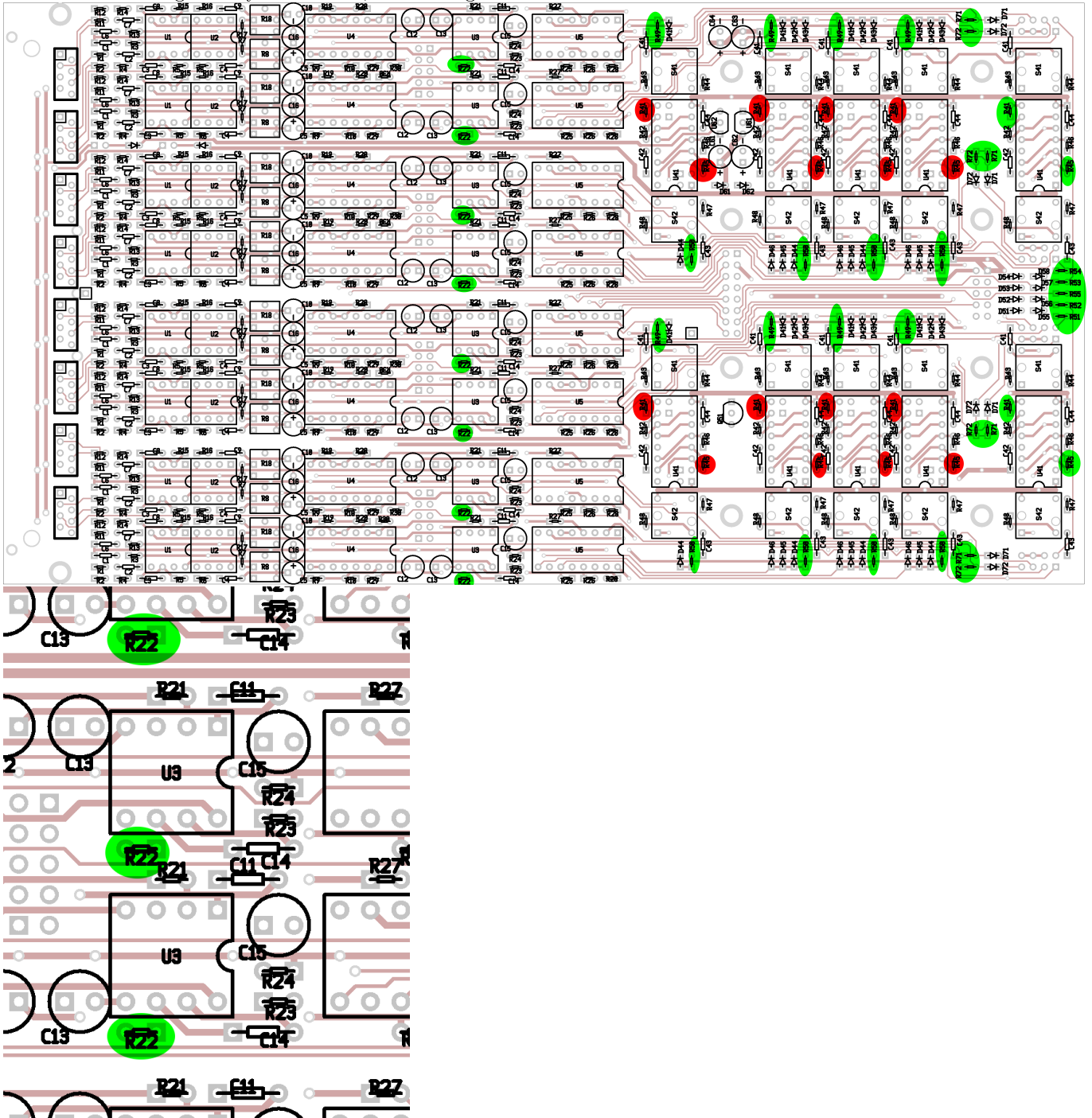

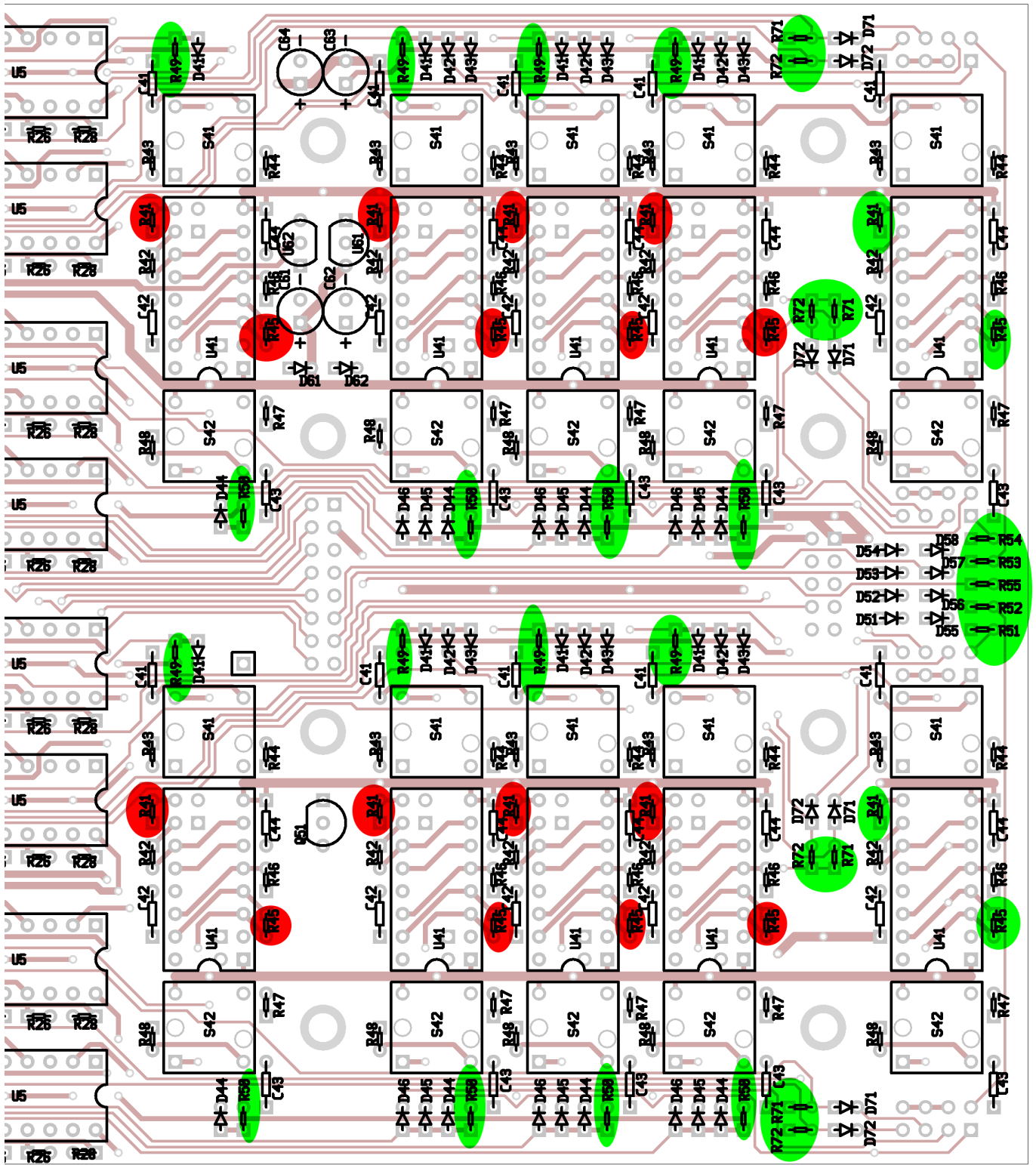

13. (20 or 4) 1000 ohm (1k) resistors (brown black black brown brown) (“10011”)  
 The full module gets all 20 1k resistors, shown both red and green.  
 The basic module gets only 4 of them, shown in green.

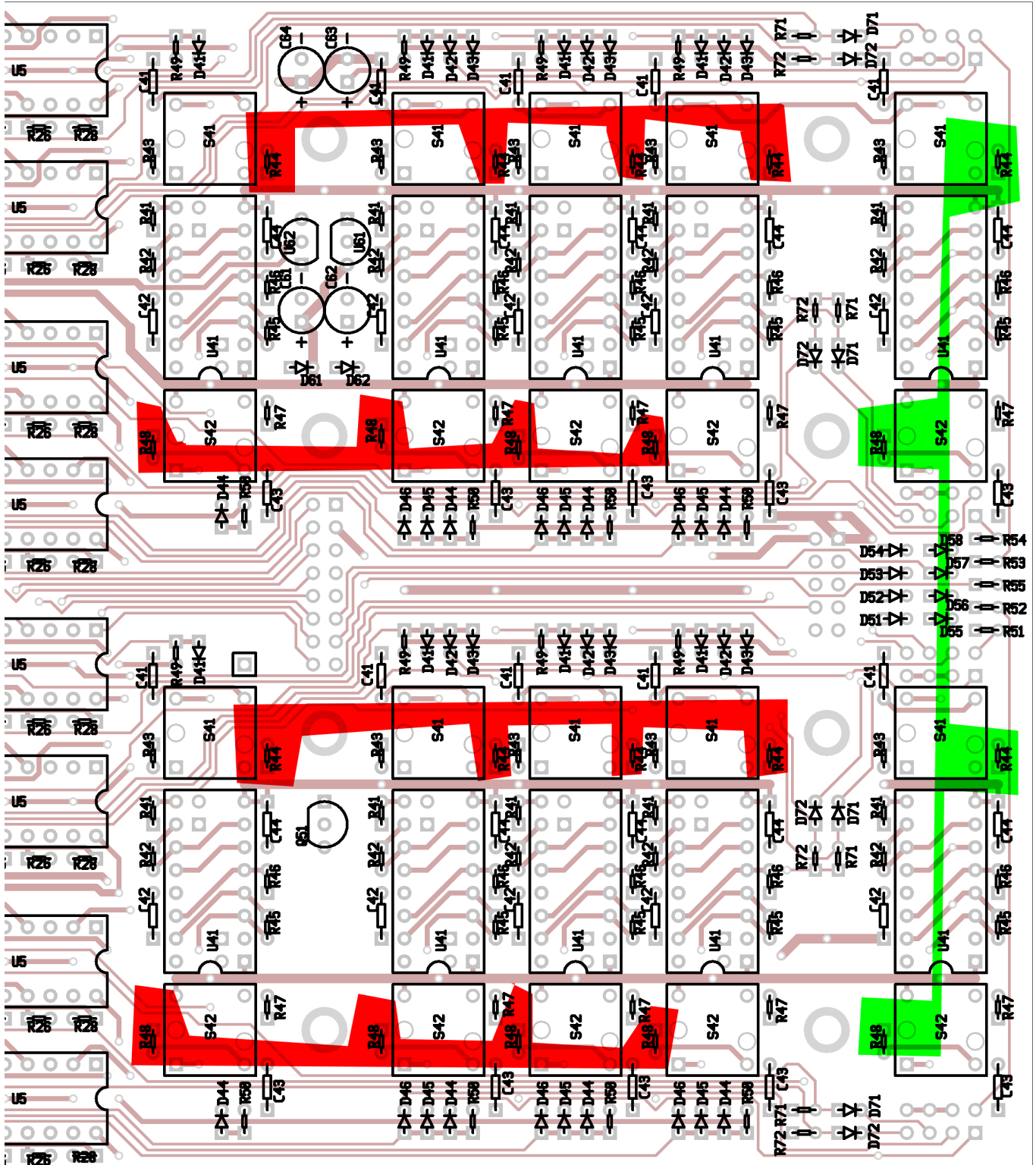

14. (20 or 4) 1 meg resistors (brown black black yellow brown) (“10041”)  
 The full module gets all 20 1 meg resistors, shown both red and green.  
 The basic module gets only 4 of them, shown in green.

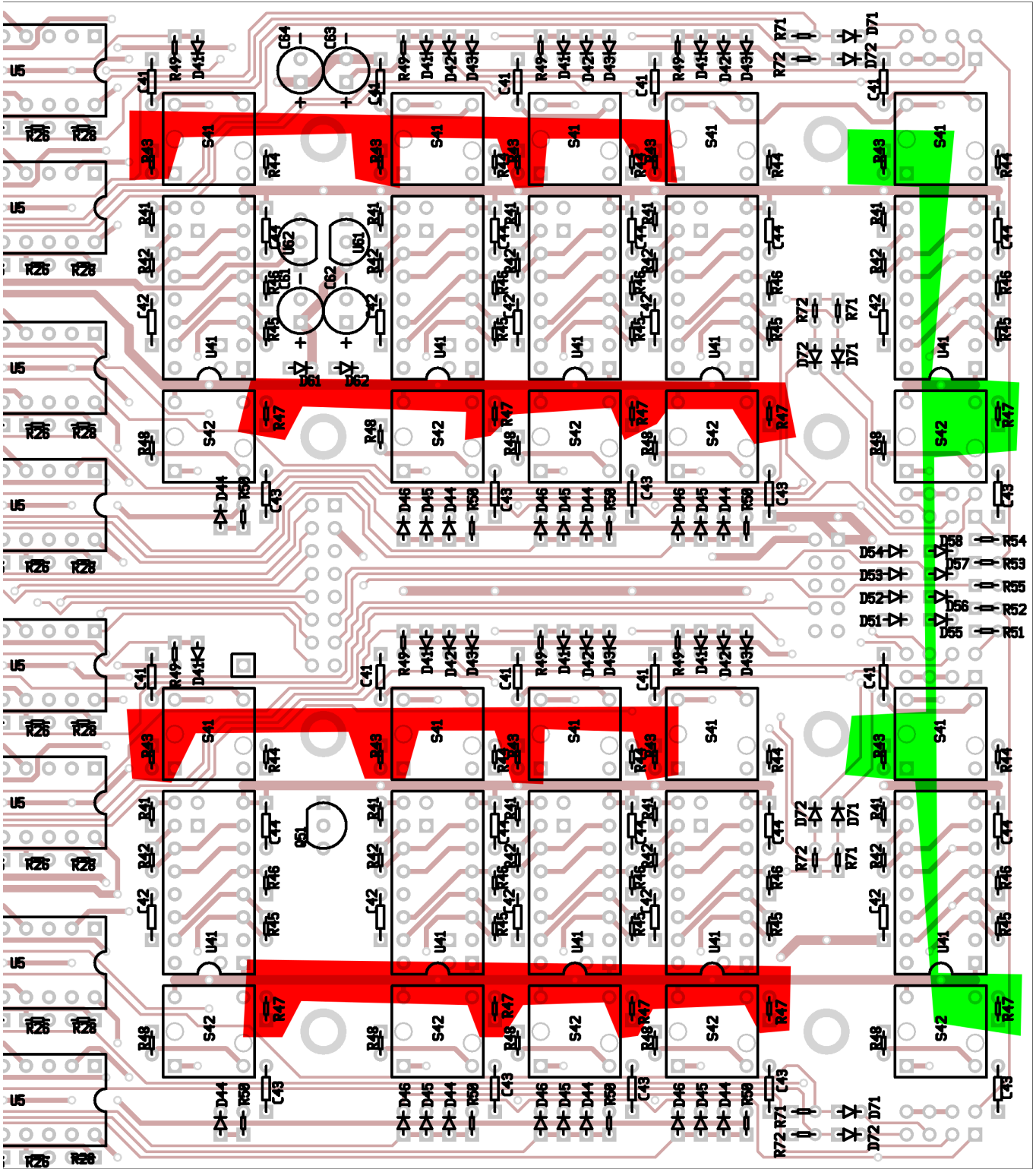

15. (4) Power diodes 1N4007  
Note polarity! The stripe is the “cathode”, matches the bar on the diagram.  
Bend leads so the stripe is up. Install so the body is at the fat end of the triangle.
16. (1) BC550C transistor – note orientation.
17. (1) 78L05 positive voltage regulator – note orientation.
18. (1) 79L05 negative voltage regulator – note orientation. (shown yellow)

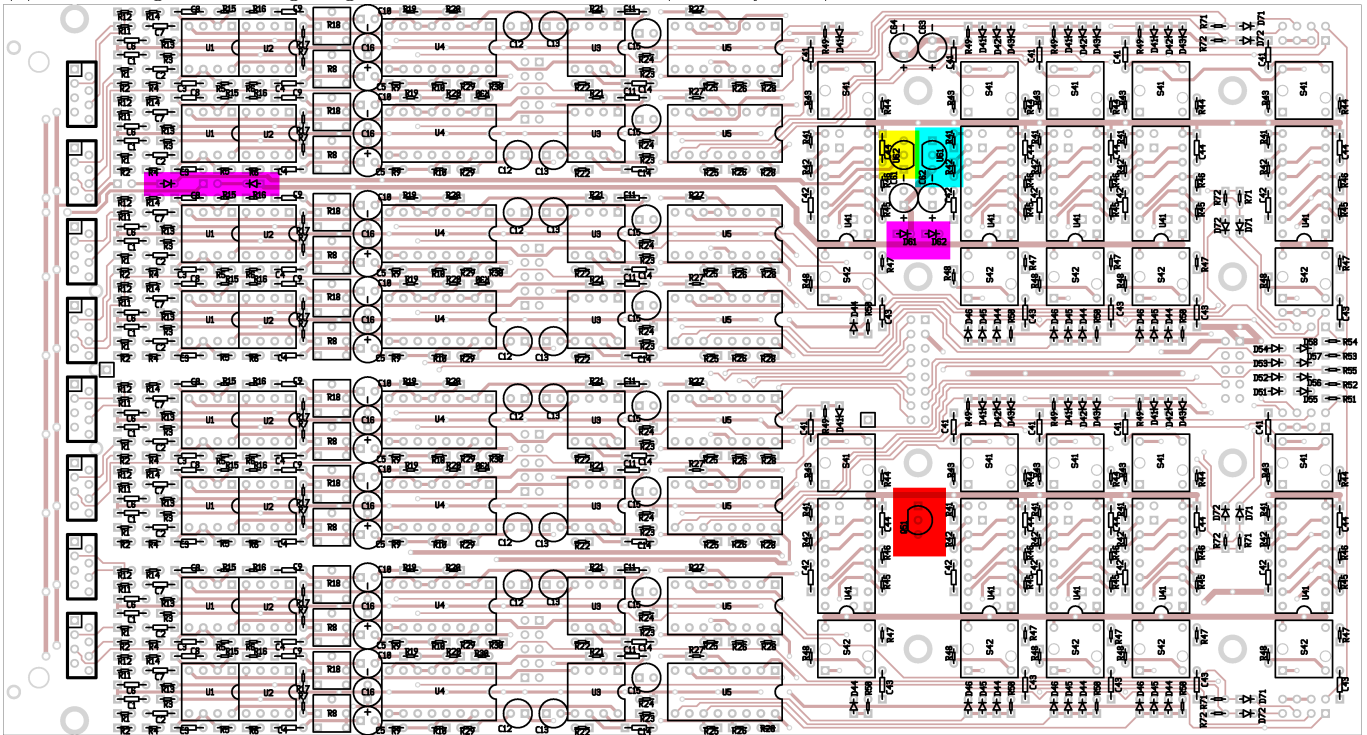

The front side of the board is mostly complete. The electrolytic capacitors, buttons, and a large connector still need to be installed. They can wait until we do the other side of the board.  
Turn the board over.

19. Basic module output select (16) 2-pin jumpers.

This is only for the “basic” input module, without the bus assign and A/B buttons.

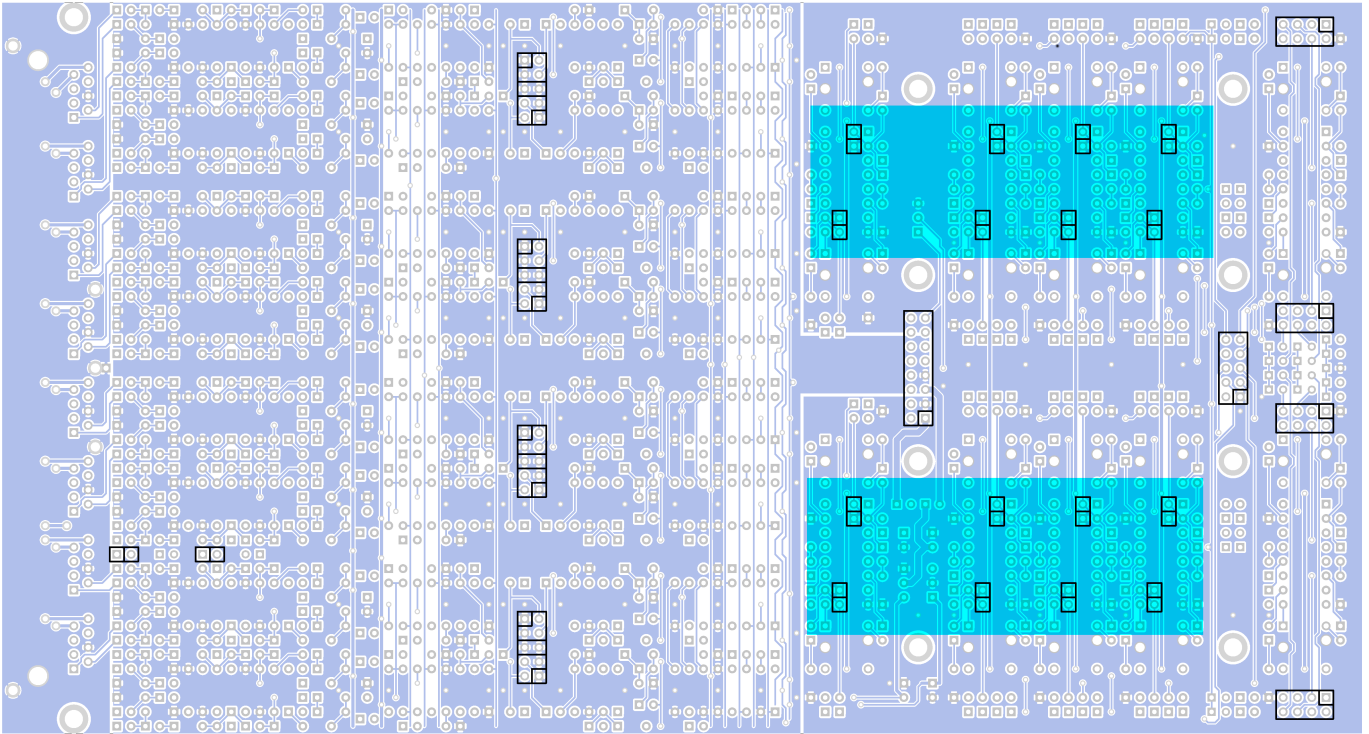

20. Jumper headers

(4) 8 pin headers. (cue, talkback, mute configuration)

(2) 2 pin headers. (RJ45 power)

You may prefer to put the power jumpers on the component side of the board.

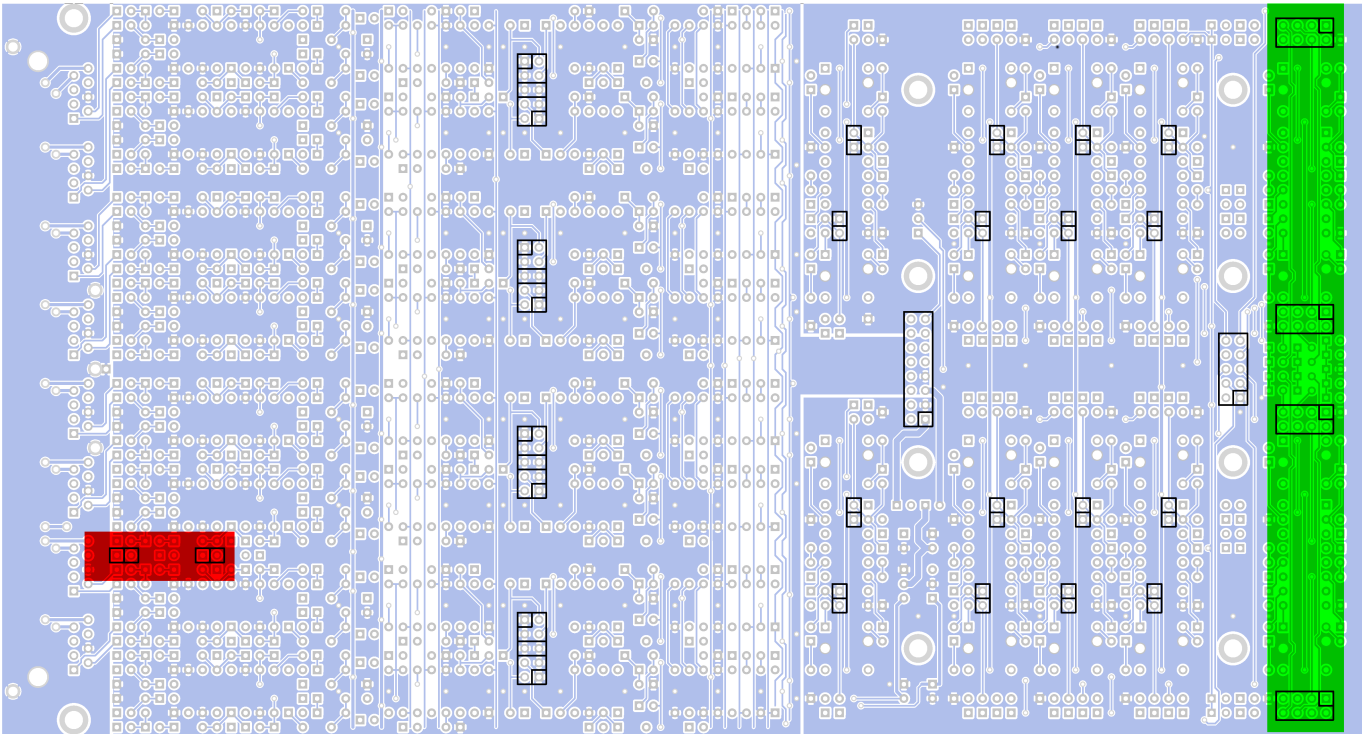

21. (6) Rectangular connectors.

One has 16 pins.

5 have 10 pins.

Be sure they are oriented correctly. The cutouts should all face the button end of the board.

To make sure it is seated, solder one pin then check. Reheat if necessary.

Then solder the other pins.

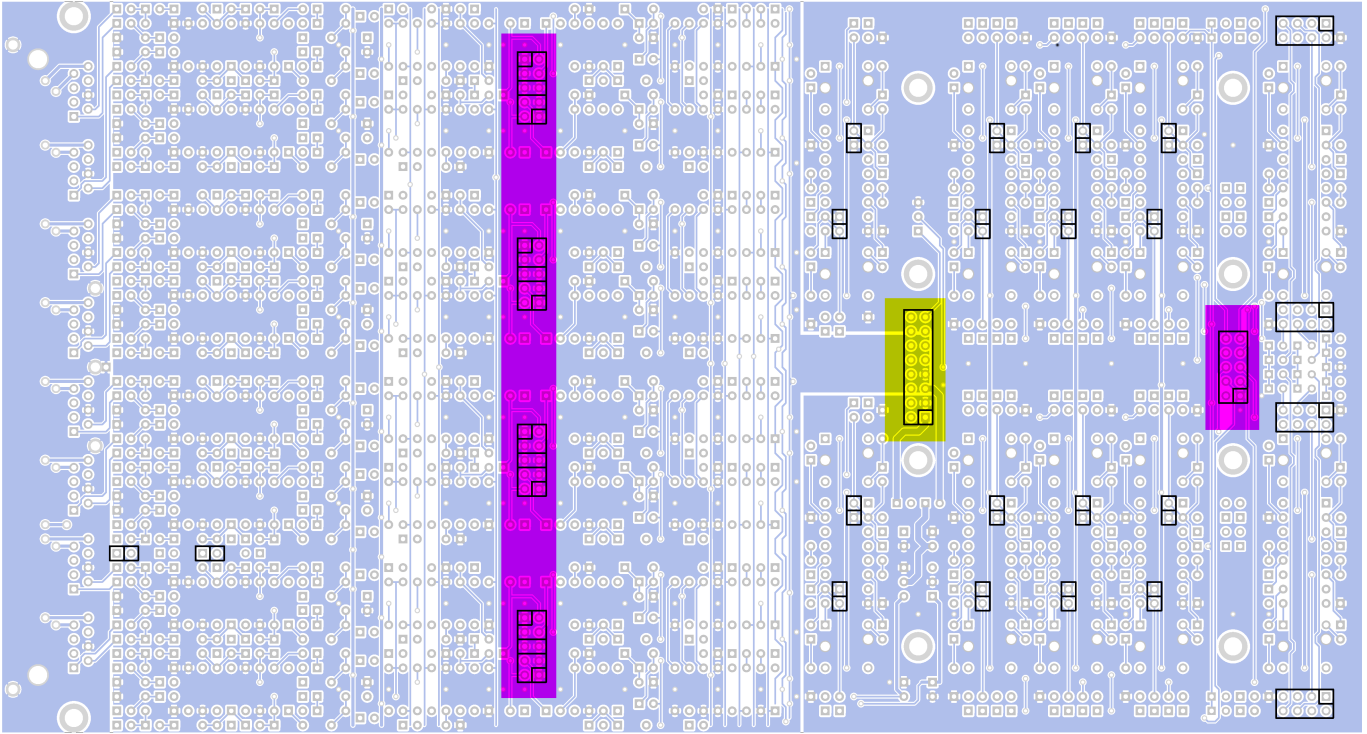

The back side of the board is complete now.

Turn it over to install the big parts on the front.

22. (12) 47 uf polarized electrolytic capacitors

These are polarized so they must be installed in the correct direction.

The “+” lead is the longer lead.

The “-” lead is marked on the body.

For all of them here, the “+” lead faces the bottom as shown in the pictures.

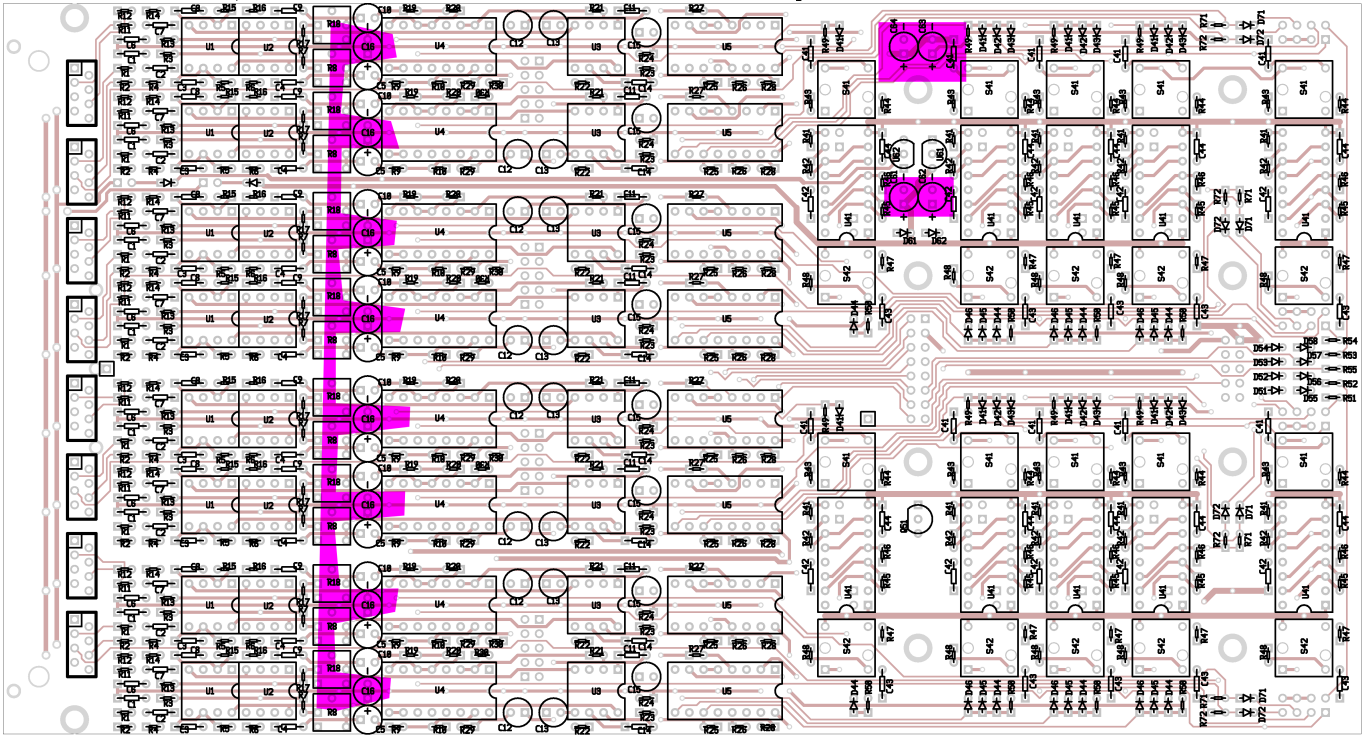

23. (40) 22uf “bi-polar” capacitors

These are audio coupling capacitors, non-polarized.

All remaining capacitors are this type.

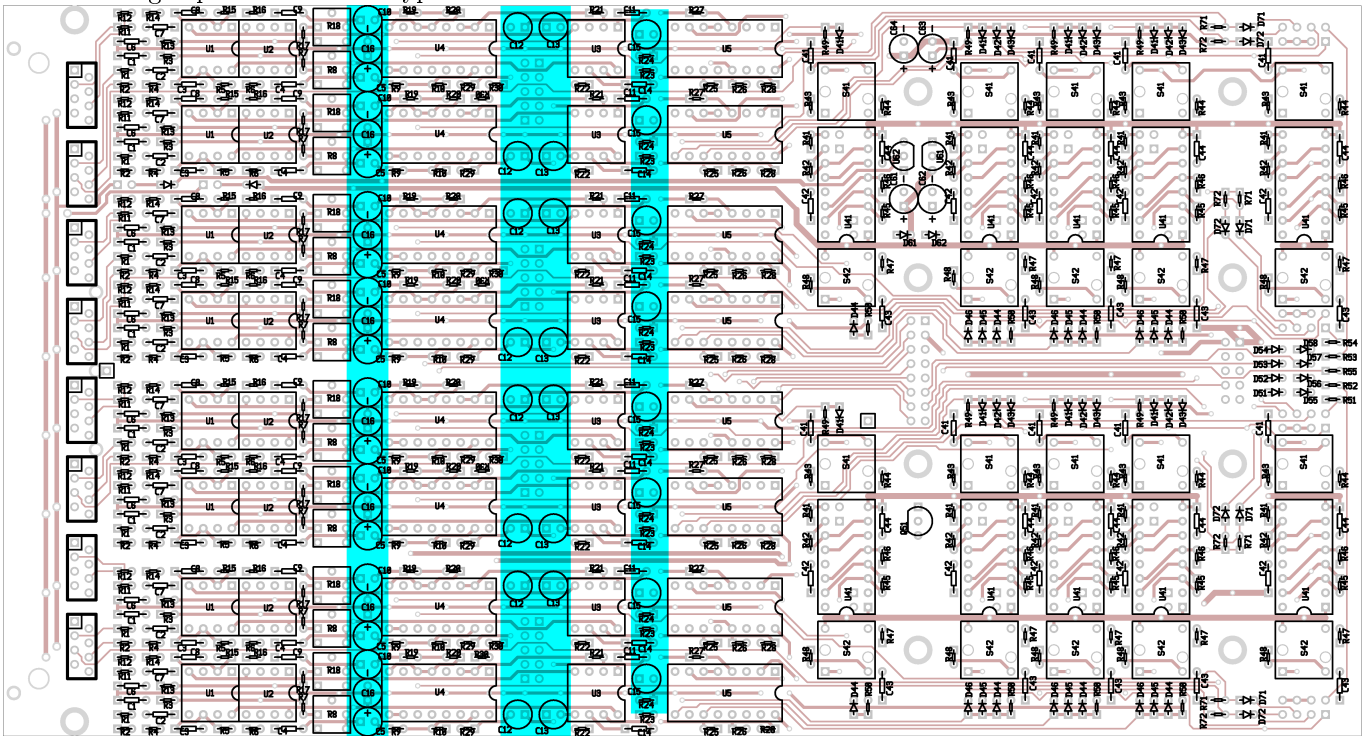



24. (1) RJ-45 input connector.  
It snaps in. It may take a bit of force.

25. (1) Ground jumper wire.  
This jumper connects the jack ground to the power ground.

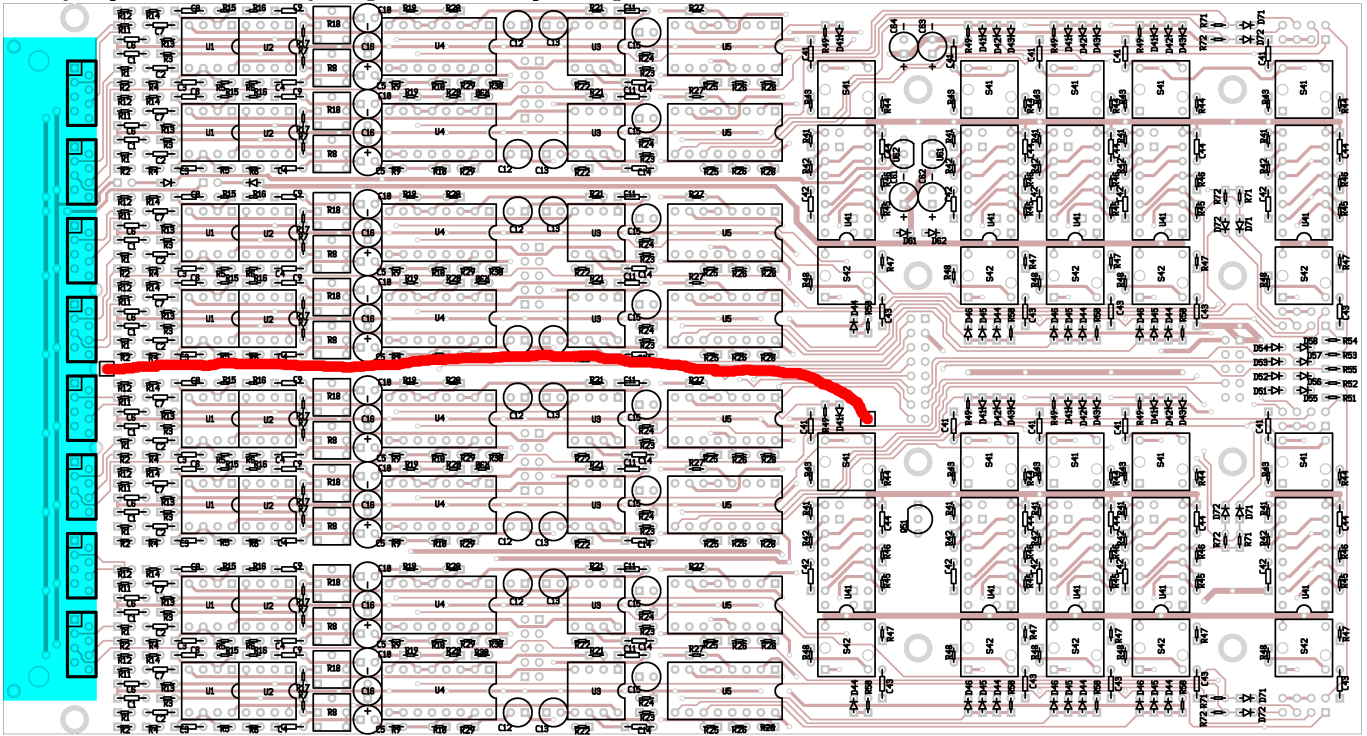

26. (20 or 4) Buttons  
 (4) Orange buttons for Cue (All)  
 (12) White/Yellow buttons for assign. (Full module only.) (White with Yellow light)  
 (4) White/Blue buttons for A/B (Full module only.) (White with Blue light)  
 Do not confuse the “white/yellow” with “white/blue”.

Be sure the buttons are seated properly to line up with the panel.  
 To make sure it is seated, solder one pin then check. Reheat if necessary.  
 Then solder the other pins.

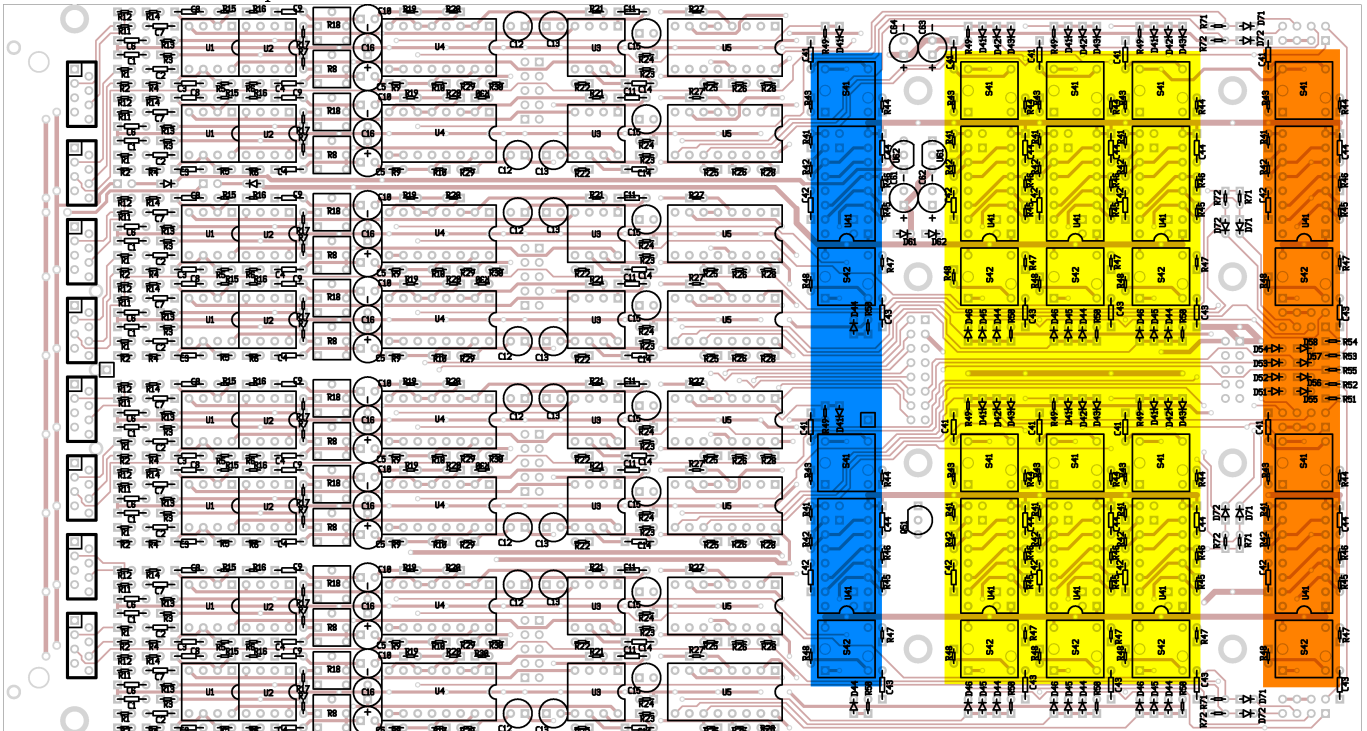

27. (24) LF353 IC's (TL072 may be used as a substitute)  
The label text should be upside-down if the board is oriented as pictured.
28. (16) 4053 IC's  
The label text should be upside-down if the board is oriented as pictured.
29. (10 or 2) 4049 IC's  
The label text should appear correct when the board is positioned with the big connector on top. The chips shown in yellow are for the full module only.

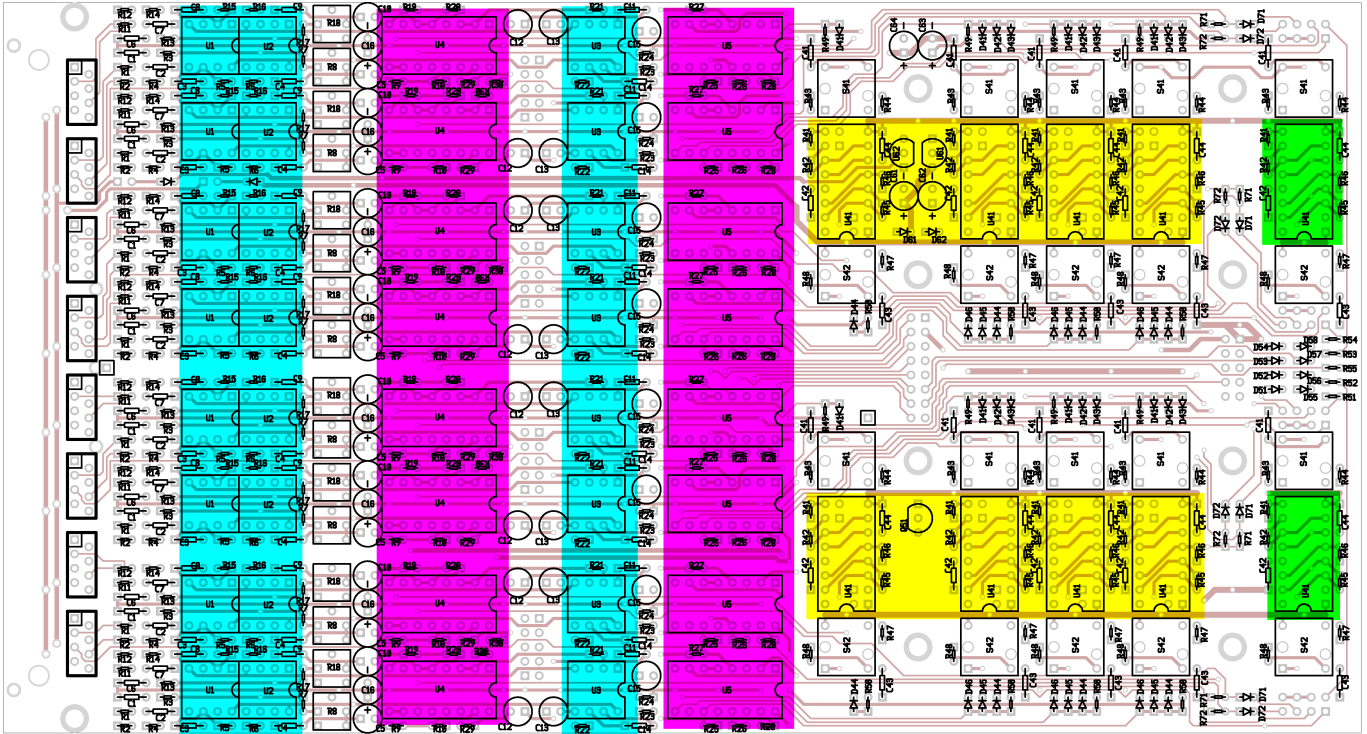

The board is now complete, ready to mount on the panel.